

# Outpatient Health Care Usability Profile V4

---

Drum, C.E., Davis, C.E., Berardinelli, M., Cline, A., Laing, R., Horner-Johnson, W., & Krahn, G.

**This tool reflects **FEDERAL** guidelines. It is necessary to verify whether your state or local codes have more stringent accessibility requirements; if so, they take precedence.**



© Copyright 2008 Oregon Health & Science University RRTC: Health & Wellness

Funded by the National Institute on Disability and Rehabilitation Research Office of Special Education and Rehabilitative Services, U.S. Department of Education. Grant Number H133B040034.

Graphic images used with permission from the Kentucky Department of Vocational Rehabilitation.

RRTC: Health & Wellness  
Oregon Institute on Disability & Development  
707 SW Gaines Street  
Portland, OR 97239  
(voice) 503-494-3534  
Relay 7-1-1  
[rrtc@ohsu.edu](mailto:rrtc@ohsu.edu)  
[healthwellness.org](http://healthwellness.org)



# Outpatient Health Care Usability Profile V4-Fed

Date \_\_\_\_\_

- Pre-Survey
- Post-Survey

Clinic Name \_\_\_\_\_

Address \_\_\_\_\_  
\_\_\_\_\_

Contact Info \_\_\_\_\_  
NAME

\_\_\_\_\_  
PHONE

\_\_\_\_\_  
EMAIL ADDRESS

Start Time \_\_\_\_\_ End Time \_\_\_\_\_

## Notes:

- Parking Lot
- Parking Garage
- Bathroom \_\_\_\_\_ (Specifically indicate which bathroom used on Pre-Survey pp. 34-43.)
  
- Lifts (Check if clinic has lifts to survey)
- Elevators (Check if clinic has an elevator to survey)
- Stairs (Check if clinic has stairs to survey)

## Contents

Tips on Completing the OHCUP .....	4
Frequently Asked Questions .....	6
Section 1: Patient Arrival .....	7
Parking .....	7
Approach to Building.....	9
Ramps .....	11
Signage .....	13
Controls .....	17
Doors .....	18
Section 2: Public Facilities.....	20
Telephones.....	20
Seating .....	22
Counters .....	23
Passageways .....	24
Water Fountains .....	26
Lifts .....	28
Elevators.....	29
Stairs .....	33
Rest Rooms .....	35
Emergency Egress (a route or path for going out in case of an emergency) .....	44
Section 3: Exam Rooms and access to Primary Services.....	46
Appendix A: Parking Requirements .....	56
Appendix B: Overall Scoring Sheet .....	57
How to calculate your overall score.....	61
Appendix C: Mobility Scoring Sheet .....	62
How to calculate your mobility score .....	66
Appendix D: Sensory Scoring Sheet .....	67
How to calculate your sensory score.....	69
Appendix E: Cognitive Scoring Sheet.....	70
How to calculate your cognitive score .....	72

## Tips on Completing the OHCUP

**Read** the OHCUP thoroughly to become familiar with the questions and flow. It will take a minimum of two hours to complete the survey for each clinic. Allow yourself time to greet the staff and answer any questions they may have.

The OHCUP is divided into three sections:

1. **Patient Arrival:** *Starts at the parking lot and examines the path of travel to the clinic. This includes entrance ramps and doors, controls, directional signage to the clinic and directional signage within the clinic.*
2. **Public Facilities:** *Includes telephones, water fountains, waiting room seating and reception counters, passageways, emergency egress and, perhaps most important, restrooms. Lifts, elevators and stairs are surveyed only if needed to enter or exit the clinic.*
3. **Exam Rooms and Access to Primary Services:** *Includes the clinic's accessible exam room and restroom most frequently used (restroom adjoining the lab specimen collection restroom, if applicable).*

Within each **Section** you will also find **Subsections** that provide additional information to help you complete specific areas within the clinic. Some questions include graphics to provide a visual cue for taking measurements.

At the end of each section, a space for notes is provided. Many OHCUP questions are generalized and may apply to several locations within a clinic. Use the space provided to describe elements of poor accessibility (e.g., the location of and force required to open public doors, including restroom doors) or to take note of contextual factors that may be brought to light by staff (e.g., clinic is undergoing renovations).

Within each section, each item should be judged independently from the other. You will answer **YES, NO, or N/A** (not applicable) for each item. Some sections may be irrelevant in some clinics. For example, if there are no lifts in a clinic, each question in that section would be answered "N/A".

Please read each question completely before answering and verify that you are at the correct location. Remember to answer the questions with only a **YES, NO or N/A**. This is important when it comes time to score. See Frequently Asked Questions on page 5, #3 for more information on scoring.

## **About Scoring**

You will be able to enter only a 1 or 0. “Yes” and “N/A” answers are scored as 1, which means “usable.” A “NO” answer is scored as 0, which means “not usable.” There are scoring sheets at the end of the OHCUP with further instructions. You can also use an electronic scoring sheet by contacting **Danielle Bailey** at 503-494-4858.

**Special Note: Whenever a sign using the International Symbol of Accessibility (ISA) is required, that symbol may not be a stylized or “designer” version of the symbol; only the prescribed ISA may be used:**



**This Checklist is NOT a substitute for federal accessibility guidelines and/or the appropriate state and local building codes.**

For more information see the *Americans with Disabilities Act Accessibility Guidelines* (ADAAG) at the US Access board website: [www.access-board.gov/gs.htm](http://www.access-board.gov/gs.htm) .

## Frequently Asked Questions (FAQ)

### Q 1. What equipment will I need to complete the survey?

You will need a pencil, measuring tape (25' or longer), and a SmartTool or other level that can determine slope measurement. Although the OHCUP does not ask about door-opening pressure, we recommend that you use a door pressure gauge (or a fish scale) to test doors for number of pounds of pressure needed to open them (the degree of opening difficulty). It should take no more than 5 pounds of pressure to open an **interior** door. (Your state may or may not have **exterior** door-opening requirements. Contact your state and local building codes for details. In Oregon, for example, it should take no more than 8 ½ pounds of pressure to open an **exterior** door. *Even if your state has no specific requirements regarding exterior doors, it is wise to test exterior doors and adjust each one to the least feasible door opening pressure.* )

### Q 2. What about the required number of accessible parking spaces needed? Must I count all the spaces in the lot?

Yes. Appendix A shows a chart for determining the required number of accessible spaces needed based on the total number of spots in the whole parking lot. The text at the bottom of that chart box explains that for outpatient clinics, the number of accessible spaces required is 10% of the total number of spaces provided. (If 10% of the total number comes out as a fraction, it is necessary to use the next largest whole number as the required number. That means if you have 83 parking spaces in a lot, 10% would be 8.3 spaces, so the actual number of required accessible spaces would be 9.)

### Q 3. How do I answer a question if part of it can be answered “yes” and part can be answered “no”?

Answer the question “no” if ALL parts of the question cannot be answered “yes.” One question about restrooms, for example, says, “**All** dispensers and hand dryers are operable with a closed fist.” Because the hand dryer and the soap dispenser are operable with a single, closed fist, we might be tempted to answer affirmatively; however, we notice that the toilet seat cover dispenser is not operable with a single closed fist. We must answer “no” to the entire question. Keep in mind that some paper towel dispensers, even those with an automatic sensor, may still not operable with a single, closed fist. Typically, the only accessible hand dryer is the hot-air blower type with push button or automatic sensor. If you are in doubt, simply try using only one hand, held in a loose clenched-fist position, to get a paper towel from a dispenser.

### Q 4. What if there is more than one restroom in the clinic? Which one should I survey?

The OHCUP has a section to use to evaluate a single restroom. **Only one restroom’s survey** results can be used in the final scoring. You will want to report the scores of the restroom that clinic patients use the most and record the location on the cover sheet if you plan to do a 9-month follow-up (post) survey.

---

## Section 1: Patient Arrival

---

### ***Parking - applies only to parking area within the immediate vicinity of the clinic***

---

1. The required number of designated parking spaces are provided (i.e. 10% of total parking spaces) and each designated space has a sign that displays the International Symbol of Accessibility shown to the right (see Appendix A).

- Yes  
 No



2. At least one in every eight designated parking spaces is van accessible.

- Yes  
 No

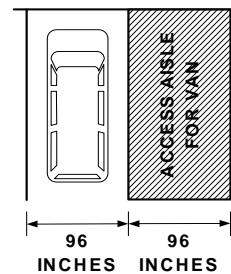

3. There are 98 inches of vertical clearance available for lift-equipped vans.

- Yes  
 No  
 N/A

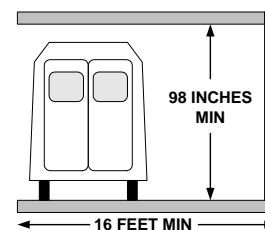

Mark "N/A" only if vehicles are parked in an open area (with any overhanging foliage above 98") and not in a parking garage.

---

- 
4. All designated parking spaces are on the shortest route of travel to the building's accessible entrance.  Yes  No
- You may have to ask what the clinic considers their "accessible" entrance.
- 

5. Access aisles are present between designated spaces and surfaces are firm, stable and slip resistant.  Yes  No
- 

6. In designated passenger loading zones, there is an access aisle at least 5 feet wide and 20 feet long adjacent and parallel to a vehicle pull-up space.  Yes  No  N/A

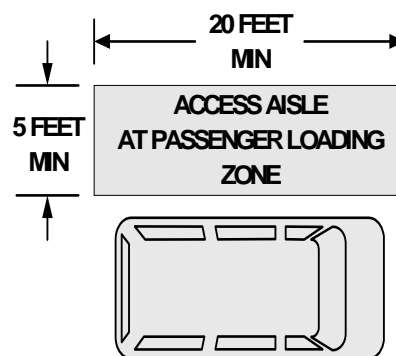

May be marked "Patient Drop-Off" or alternatively identified with signs or painted stripes. **If no identifiable zone, then mark "N/A."**

---

7. Curb ramps in the parking area have a smooth transition from the ramp to the pedestrian route of travel.  Yes  No  N/A
- Mark "N/A" only if curb ramps are unnecessary.
-





11. All curbs on the route of travel have curb ramps.	<input type="checkbox"/> Yes <input type="checkbox"/> No <input type="checkbox"/> N/A	<p>If no curbs, then write "N/A." Ramp should have a slope no greater than 1:12 (measured at steepest point), stable, firm, and slip resistant, 36 inches wide exclusive of flared sides. If ramp does not meet these criteria, mark "No."</p>
12. Where there are stairs at the main entrance, there is either a ramp, lift, or an alternative entrance provided.	<input type="checkbox"/> Yes <input type="checkbox"/> No <input type="checkbox"/> N/A	<p>Mark "N/A" if there are no stairs at main entrance.</p>
13. When alternative entrances are used, there is a sign at the main entrance indicating the location of the alternative entrance.	<input type="checkbox"/> Yes <input type="checkbox"/> No <input type="checkbox"/> N/A	<div data-bbox="954 758 1084 940" data-label="Image"> </div> <p>Mark "N/A" only if there are no alternative entrances used.</p>
14. Alternative entrances can be used without assistance.	<input type="checkbox"/> Yes <input type="checkbox"/> No <input type="checkbox"/> N/A	<p>Mark "N/A" only if there are no alternative entrances used.</p>
15. The entrance door has at least 32 inches clear opening (for a double door, at least one leaf with a 32- inch clear opening).	<input type="checkbox"/> Yes <input type="checkbox"/> No	<p>32 INCHES MIN CLEAR OPENING</p>
16. There are at least 18 inches of clear, unobstructed wall space next to the latch side of the door (to get in <b>and</b> out).	<input type="checkbox"/> Yes <input type="checkbox"/> No <input type="checkbox"/> N/A	<p>18 INCHES MIN</p> <p>If the door is automatic, mark "N/A."</p>



20. The unobstructed width of the ramp is 36 inches.
- Yes
- No
- N/A

21. Any ramp that rises more than 6 inches or is longer than 72 inches has handrails on both sides.
- Yes
- No
- N/A

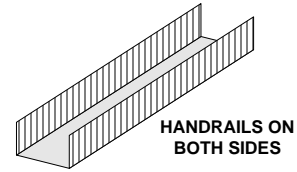

22. The tops of the handrails are between 34 and 38 inches above the ramp surface.
- Yes
- No
- N/A

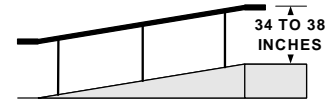

23. When the ramp changes direction, there is a level landing of at least 60 by 60 inches.
- Yes
- No
- N/A

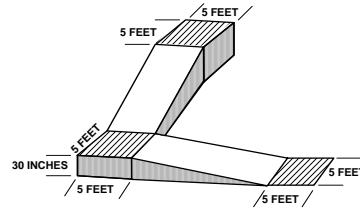

**NOTES : RAMPS**

---



---



---



---



---



---



---



---



---



---

---

**Signage (those that direct to and within a clinic only)**

---

**Section A (Questions 24-26): Signs mounted above 80 inches.**

Measure signs along path of travel from building entrance to clinic entrance, and within clinic itself.

---

24. If mounted above 80 inches, characters on signs that provide directions and information have letters at least 3 inches high.

Yes  
 No  
 N/A

Mark "N/A" if no signs are mounted above 80 inches.

---

25. If mounted above 80 inches, characters on signs that provide directions and information have high contrast.

Yes  
 No  
 N/A

Mark "N/A" if no signs are mounted above 80 inches.

---

26. If mounted above 80 inches, characters on signs that provide directions and information have a non-glare finish.

Yes  
 No  
 N/A

Mark "N/A" if no signs are mounted above 80 inches.

---

**NOTES : SIGNS MOUNTED ABOVE 80 INCHES**

---

**Section B (Questions 27-35): Measure signs within clinic only.**

---

27. Signs designating all permanent rooms and spaces are present
- Yes
- No

28. Signs are mounted with centerlines 60 inches from floor.

- Yes
- No
- N/A

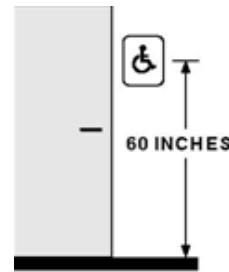

Measurement of 60 inches should be taken from the middle of the sign.

Mark "NA" if answer to Q27 is "No."

29. Signs are mounted on the wall adjacent to the latch side of the door and outside the door swing.

- Yes
- No
- N/A

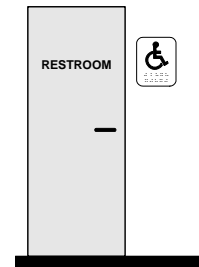

Mark "NA" if answer to Q27 is "No."

30. Signs have characters and background with a non-glare finish.

- Yes
- No
- N/A

Mark "NA" if answer to Q27 is "No."

---

31. Signs have raised characters.	<input type="checkbox"/> Yes <input type="checkbox"/> No <input type="checkbox"/> N/A	Mark "NA" if answer to Q27 is "No."
-----------------------------------	---------------------------------------------------------------------------------------------	-------------------------------------

---

32. Signs feature high contrast lettering and backgrounds.	<input type="checkbox"/> Yes <input type="checkbox"/> No <input type="checkbox"/> N/A	Mark "NA" if answer to Q27 is "No."
------------------------------------------------------------	---------------------------------------------------------------------------------------------	-------------------------------------

---

33. Signs feature Braille text.	<input type="checkbox"/> Yes <input type="checkbox"/> No <input type="checkbox"/> N/A	Mark "NA" if answer to Q27 is "No."
---------------------------------	---------------------------------------------------------------------------------------------	-------------------------------------

---

34. When a pictogram is used to designate rooms and spaces, it is accompanied by raised characters and Braille.	<input type="checkbox"/> Yes <input type="checkbox"/> No <input type="checkbox"/> N/A	Mark "N/A" if no pictograms are used.
-----------------------------------------------------------------------------------------------------------------	---------------------------------------------------------------------------------------------	---------------------------------------

---

35. If signs designating rooms and spaces do not have raised characters, Braille, or pictograms, or are not present, there is other directional assistance available (i.e., sound recordings, or a receptionist always nearby).	<input type="checkbox"/> Yes <input type="checkbox"/> No	
---------------------------------------------------------------------------------------------------------------------------------------------------------------------------------------------------------------------------------	-------------------------------------------------------------	--

---

**NOTES : SIGNS WITHIN CLINIC**

---

---

---

---

---

---

---

---

---

---

---

**Section C (Question 35): Measure sign at clinic entrance only.**

---

36. Sign is present at entrance to clinic at a height of 60 inches to centerline and features high contrast, raised and Braille characters, and non-glare finish.
- Yes
- No
- 

**NOTES : SIGN AT CLINIC ENTRANCE**

---

---

---

---

---

---

---

---

---

---





**Doors (within the clinic building, excluding the entrance doors)**

39. When a door is opened to 90 degrees, there is a clear opening width of at least 32 inches measured between the face of the door and the door stop on the latch side.
- Yes
- No
- N/A

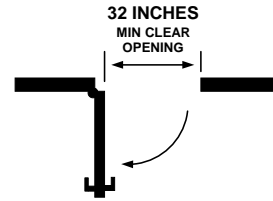

Mark "N/A" only if no doors are used within clinic.

40. Clear space between doors in a series is at least 48 inches.
- Yes
- No
- N/A

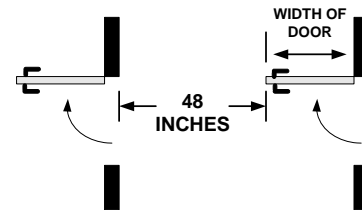

If both doors are automatic, then mark "N/A."

41. There is at least 18 inches of clear wall space on the latch side of doors (to get in **and** out).
- Yes
- No
- N/A

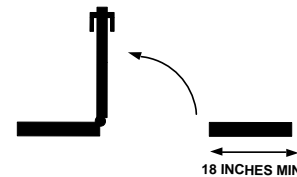

Judge doors from waiting room to exam room/ lab restroom on the path of travel only.

Mark "N/A" if door can be operated automatically.

42. The operating hardware is mounted no higher than 48 inches above the floor.
- Yes
- No
- N/A

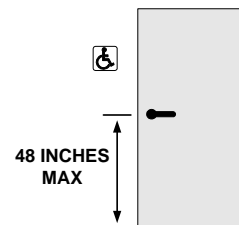

If door opens automatically with a sensor, enter "N/A."

43. All handles, locks, and latches or other opening  Yes

hardware are operable with a single closed fist.  No  
 N/A

Mark "N/A" only if no doors are used within clinic. If operated by a control device, consider whether it is usable with closed fist.

44. All threshold edges are 1/4 inch high or less, or if beveled edge, no more than 1/2 inch high.  Yes  
 No  
 N/A

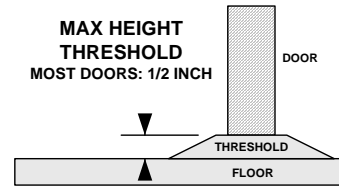

45. No more than five pounds of force is required to open an interior door (e.g., restroom door). For information about exterior door opening pressure, see FAQ #1, page  Yes  
 No  
 N/A

Mark "N/A" if all doors used by public are automatic.

**NOTES : DOORS**

---



---



---



---



---



---



---



---

---

## Section 2: Public Facilities

---

### *Telephones (any available for public use along path of travel)*

---

Mark "N/A" if **no** telephone is available for public use. Any phone for public use should be assessed, even if it is not a pay phone.

---

46. The designated telephone has at least 30 by 48 inches of clear floor space.

- Yes
- No
- N/A

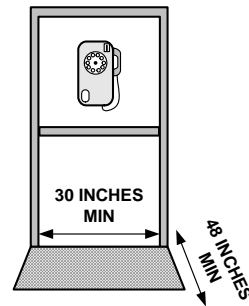

47. The route to the telephone is at least 36 unobstructed inches wide adjoining or overlapping the clear floor space.

- Yes
- No
- N/A

48. The highest operable part of the phone is no higher than 48 inches. Be sure to check coin and/or credit card slot height.

- Yes
- No
- N/A

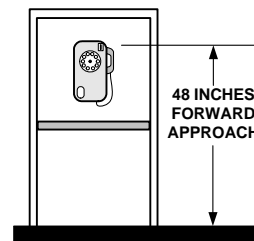

49. If a wall-mounted telephone has a leading edge between 27 and 80 inches from the floor, it projects less than 4 inches into the pathway.
- Yes
  - No
  - N/A

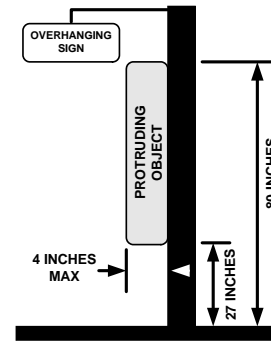

Enter "Yes" if telephone is recessed and not projecting into passageway.

50. The designated phone is adapted with volume control.
- Yes
  - No
  - N/A

Alternatively, look for volume adjustment button near keypad.

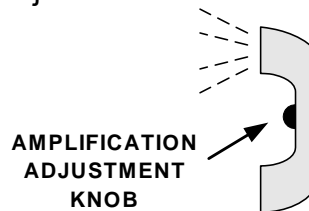

51. Volume controlled telephones are identified by a sign showing a handset radiating sound waves.
- Yes
  - No
  - N/A

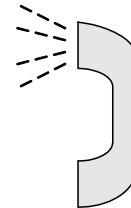

52. When telephone banks (2 or more adjacent public phones) do not contain a text telephone (TTY), there is a sign to indicate location of nearest TTY.
- Yes
  - No
  - N/A

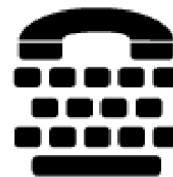

**NOTES : TELEPHONE**

---

---

---

---

---

---

---

***Seating (in waiting area only)***

- 
- |                                                                          |                                                                                             |                                                       |
|--------------------------------------------------------------------------|---------------------------------------------------------------------------------------------|-------------------------------------------------------|
| 53. All aisles between seating are at least 36 unobstructed inches wide. | <input type="checkbox"/> Yes<br><input type="checkbox"/> No<br><input type="checkbox"/> N/A | Mark "N/A" only if there is no seating area provided. |
|--------------------------------------------------------------------------|---------------------------------------------------------------------------------------------|-------------------------------------------------------|
- 
- |                                                                                                                  |                                                                                             |                                                 |
|------------------------------------------------------------------------------------------------------------------|---------------------------------------------------------------------------------------------|-------------------------------------------------|
| 54. There is a space for a person in a wheelchair to wait <u>without blocking the clear width</u> of any aisles. | <input type="checkbox"/> Yes<br><input type="checkbox"/> No<br><input type="checkbox"/> N/A | Mark "N/A" only if no seating area is provided. |
|------------------------------------------------------------------------------------------------------------------|---------------------------------------------------------------------------------------------|-------------------------------------------------|
- 

**NOTES : SEATING**

---

---

---

---

---

---

---

---



**Passageways (i.e., route of travel to clinic services excluding doorways)**

57. All passageways are at least 36 unobstructed inches wide.

- Yes
- No
- N/A

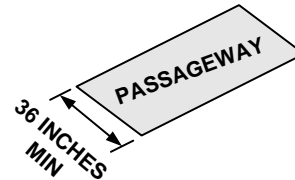

If temporary objects protrude into passageway, then measure passageway to edge of object.

58. If the passageway is **less than 60 inches wide**, there are passing spaces at least 60 inches wide and 60 inches long or intersecting walks allowing passing at reasonable intervals not exceeding 200 feet.

- Yes
- No
- N/A

If passageway is more than 60 inches wide, mark N/A.

59. There is a 5-foot circle **or** a T-shaped space (36 inches wide each direction and 60 inches minimum depth) to reverse direction.

- Yes
- No
- N/A

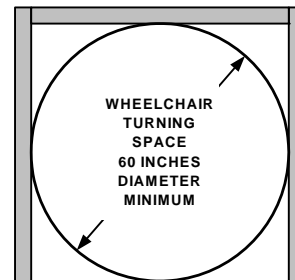

Note: This is a difficult measurement to make. It may require 2 people working together to make an accurate reading. Study the diagram closely, and take your time making your measurement.

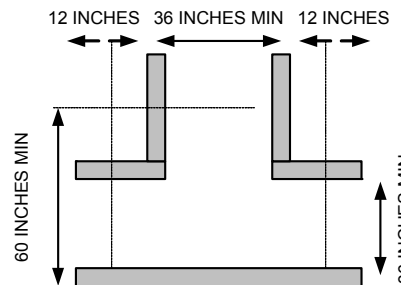



60. Where a passageway makes a U-turn around an obstacle which is less than 48 inches wide, the passageway width increases to at least 42 inches on the approaches and 48 inches in the turn.

- Yes
- No
- N/A

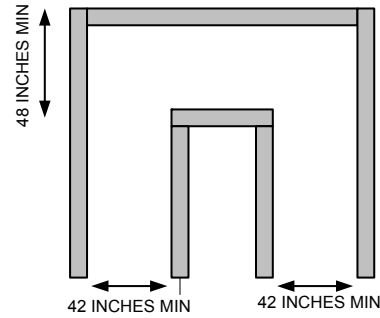

Mark "N/A" if there is no U-turn around obstacle.

61. If passageway levels change, the vertical difference is less than 1/4 inch, or if the change in level is between 1/4 and 1/2 inch, there is a beveled edge with a slope no greater than 1:2.

- Yes
- No
- N/A

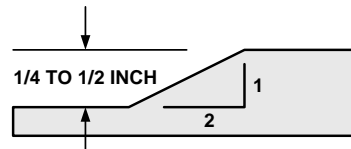

Mark "N/A" if there is no change in floor level. (This often occurs where building additions have been made.)

62. Wall-mounted objects that have leading edges between 27 inches and 80 inches from the floor project less than 4 inches into the passageway.

- Yes
- No
- N/A

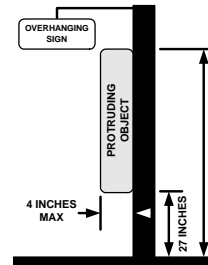

Mark "N/A" if no protruding objects are found. Objects with edges that extend below 27" are not considered obstructions because they are cane-detectable.

63. Carpeting is low-pile, tightly woven and securely attached along edges.

- Yes
- No
- N/A

**NOTES : PASSAGEWAYS**

---

---

---

---

---

---

---

---

---

---

---

***Water Fountains (where they exist along the path of travel)***

---

Mark "N/A" if no fountain is available to the public.

---

64. Where fountains are provided, there is a clear floor space of at least 30 by 48 inches.

- Yes
- No
- N/A

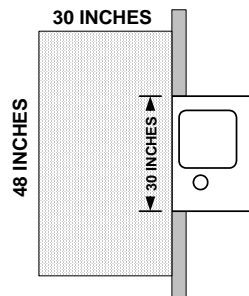

65. When fountains are provided, there is at least one fountain with its spout fixture no higher than 36 inches from the floor.

- Yes
- No
- N/A

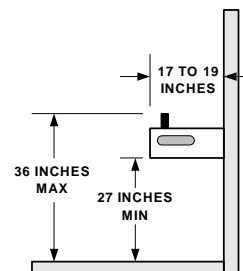



---

***Lifts (when provided along the path of travel)***

---

Mark "N/A" only if lift is not required to access clinic services and public facilities.

---

67. Where a lift is provided, it is usable without assistance (i.e., key is in lock and doesn't have to be retrieved from somewhere; door is operable with a closed fist).

Yes  
 No  
 N/A

---

68. If the lift is not usable without assistance, a call button is provided and staffed whenever the clinic is open.

Yes  
 No  
 N/A

---

69. The lift controls are operable with a closed fist.

Yes  
 No  
 N/A

---

70. The lift controls are located no higher than 48 inches for a forward approach.

Yes  
 No  
 N/A

---

71. The lift controls are located no higher than 54 inches for a side approach.

Yes  
 No  
 N/A

---



---

74. The call button has an audible signal that indicates direction of travel.

- Yes
- No
- N/A

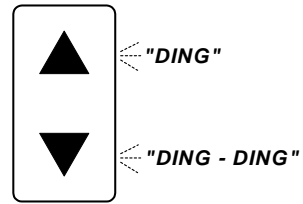

---

75. There are signs identifying the floor number in raised letters on both sides of the door jamb of the elevator at every floor.

- Yes
- No
- N/A

---

76. There are signs identifying the floor in Braille letters on both door jambs of the elevator at every floor.

- Yes
- No
- N/A

---

77. The elevator automatically comes within 1/2 inch of the floor landing at each stop.

- Yes
- No
- N/A

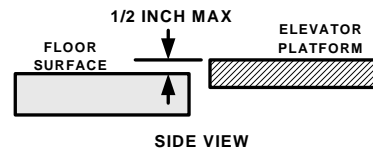

---

78. The elevator is large enough that a wheelchair user can enter, reach the controls and exit.

- Yes
- No
- N/A

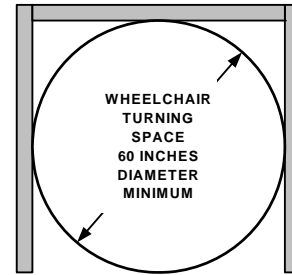

---

79. The elevator doors reopen automatically without contact if an object passes through the opening between 5 and 29 inches above the floor.

- Yes
- No
- N/A

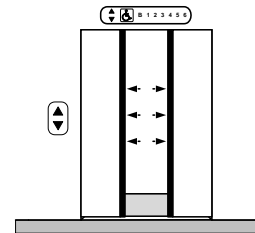

---

80. When reopened, the door stays open for **at least 20 seconds.**

- Yes
- No
- N/A

---

81. The control buttons inside the elevator have Braille lettering.

- Yes
  - No
  - N/A
-

---

82. The control buttons inside the elevator have raised lettering.

- Yes
- No
- N/A

---

83. If provided, the emergency communication system (e.g., handset, intercom) is identified in both Braille and raised letters.

- Yes
- No
- N/A

---

84. If provided, the emergency communication system (e.g., handset, intercom) is no higher than 48 inches above the floor.

- Yes
- No
- N/A

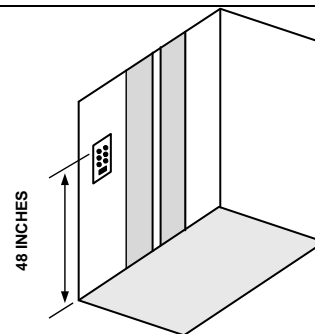

---

85. All elevator controls are no lower than 15 inches and no higher than 48 inches from floor.

- Yes
- No
- N/A

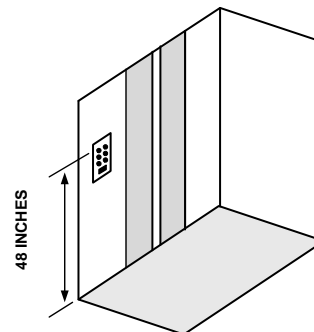

---

**NOTES : ELEVATORS**

---

---

---

---

---

---

---

---



---

## Stairs (where they exist along the path of travel)

---

Mark "N/A" only if stairs are not a part of the path to clinic services and public facilities.

---

86. Handrails have 12-inch extensions beyond the top riser.

- Yes
- No
- N/A

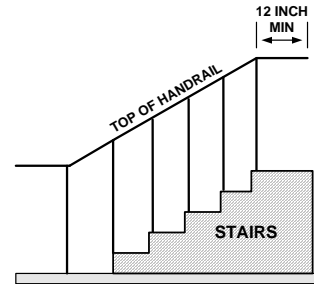

---

87. Handrails have 12-inch extensions beyond the bottom riser.

- Yes
- No
- N/A

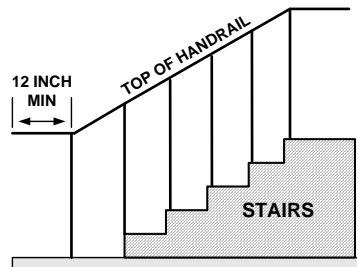

---

88. For stairs along the path of travel, the risers are closed.

- Yes
- No
- N/A

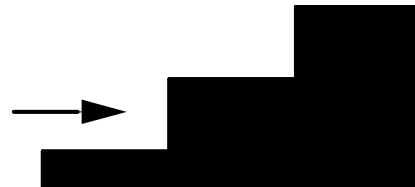

---

89. For stairs along the path of travel, the steps have uniform riser height and tread width.

- Yes
  - No
  - N/A
-

- 
90. If there are stairs between the elevator and primary clinic services, there is a designated route without stairs.
- Yes
  - No
  - N/A
- 

**NOTES : ELEVATORS**

---

**Rest Rooms (Instructions: Assess restroom in public waiting room only).**

---

**Features for both toilet stalls and toilet rooms.**

---

91. Signs are mounted on the wall on the latch side of the door, 60 inches from the floor to the middle of the sign.
- Yes  
 No

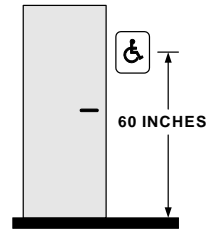

Measurement of 60 inches should be taken from the middle of the sign.

92. Where pictograms or symbols are used to identify rest rooms, Braille characters are included below them.
- Yes  
 No  
 N/A

Mark "N/A" if no pictograms are used.

93. Where pictograms or symbols are used to identify rest rooms, raised characters are included below them.
- Yes  
 No  
 N/A

Mark "N/A" if no pictograms are used.

94. The restroom doorway is at least 32 inches wide.
- Yes  
 No

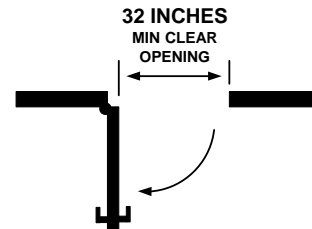

95. Doors are operable with a single, closed fist.
- Yes  
 No

If operated by a control, consider whether it is usable with a single, closed fist.

---

96. Door handles are placed no higher than 48 inches.

- Yes
- No
- N/A

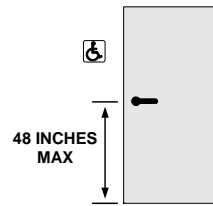

Mark "N/A" only if door is automatic and operable control is no higher than 48 inches.

---

97. The entry is large enough for a wheelchair user to enter, turn around and exit.

- Yes
- No

Note: This is a difficult measurement to make. It may require 2 people working together to make an accurate reading. Study the diagram closely, and take your time.

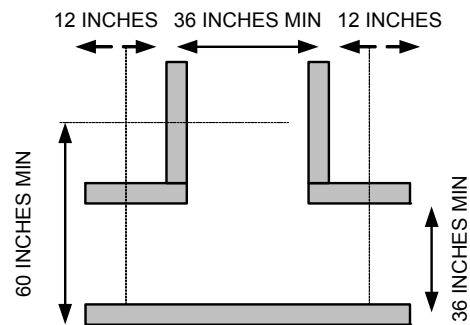
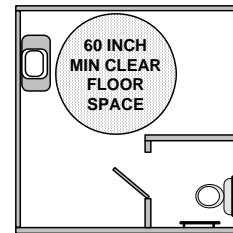

---

98. There is a 36-inch wide unobstructed path to all fixtures (e.g., sink, soap and other dispensers).

- Yes
- No

---

99. The sink has a 30-inch wide by 48-inch deep clear space in front (a maximum of 19 inches of the required depth may be under the sink).

- Yes
- No
- N/A

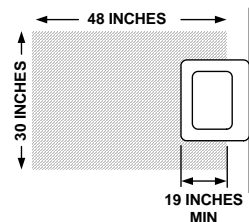

Mark "N/A" only if there is no sink.

---

---

100. Pipes under the sink are insulated to protect against contact.

- Yes
- No
- N/A

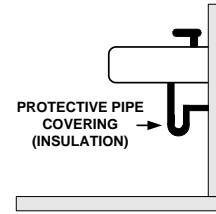

Mark "N/A" only if there is no sink.

---

101. Where counters or tables are provided, the top is between 28 and 34 inches from the floor.

- Yes
- No
- N/A

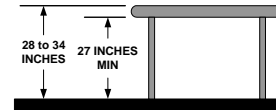

102. The sink rim is no higher than 34 inches.

- Yes
- No
- N/A

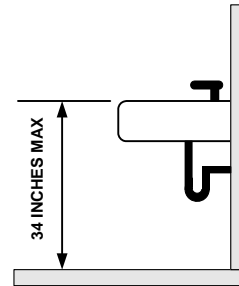

Mark "N/A" only if there is no sink.

---

103. The faucet is operable with a single closed fist.

- Yes
- No
- N/A

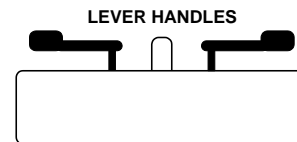

Mark "N/A" only if there is no sink.

---

104. The highest operable part of all dispensers and hand dryers is no higher than 48 inches for a forward approach.

- Yes
- No
- N/A

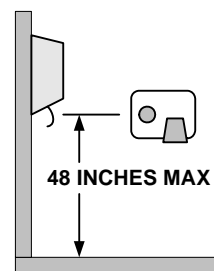

Mark "N/A" only if there are no dispensers.

---

- 
105. All dispensers and hand dryers are operable with a single closed fist (pull-down paper-towel dispensers & many seat-cover dispensers are usually not accessible by this criteria).
- Yes
- No
- N/A

Mark "N/A" only if there are no dispensers.

- 
106. The mirror is mounted with the bottom edge of the reflecting surface no higher than 40 inches.
- Yes
- No
- N/A

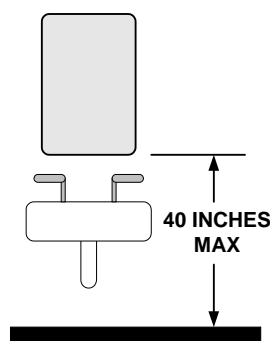

Note: This is a difficult measure to take and sometimes requires more than one measurement. Please use caution.

Mark "N/A" only if there is no mirror.

- 
107. There are two horizontal grab bars: one on the wall behind the toilet and one on the side wall nearest to the toilet in the designated stall/toilet room.
- Yes
- No

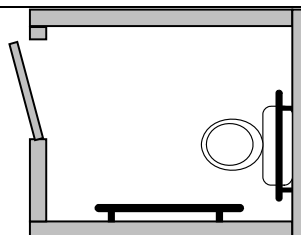

Mark "No" if grab bars are not present or are not positioned parallel to floor.

- 
108. The toilet seat is 17"-19" high. Measure from floor to top of seat.
- Yes  
 No

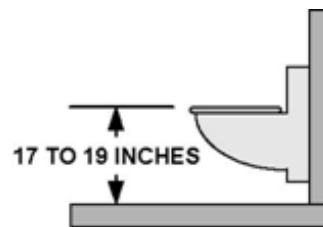

- 
109. There is at least 18 inches of clear space from the center of the toilet to the wall(s) on either side.
- Yes  
 No

Note: Make measurement to adjacent wall. Do not include objects such as toilet paper dispensers in your measurement.

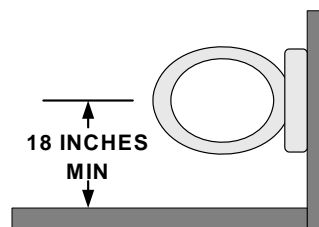

- 
110. At all rest rooms, there is a sign indicating the location of the designated rest room(s).
- Yes  
 No  
 N/A

This question is specific for other restroom locations. Mark "Yes" if non-accessible restrooms provide directional signage to accessible restroom. Mark "N/A" only if: 1) other public restrooms do not exist/are not available to public; or 2) other public restrooms are accessible.





---

**FOR TOILET STALLS ONLY**

---

Mark "N/A" if there are no toilet stalls. Proceed to next section: Toilet Room.

---

111. All stall door hardware is operable with a single, closed fist both inside and outside.
- Yes
- No
- 

112. When stall door is open 90 degrees, there is at least 32-inches' clear width.
- Yes
- No

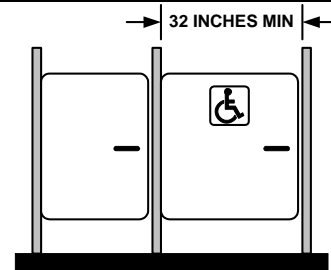

113. There is a designated stall with a clear floor space of at least 5 feet long by 5 feet wide.
- Yes
- No
- N/A

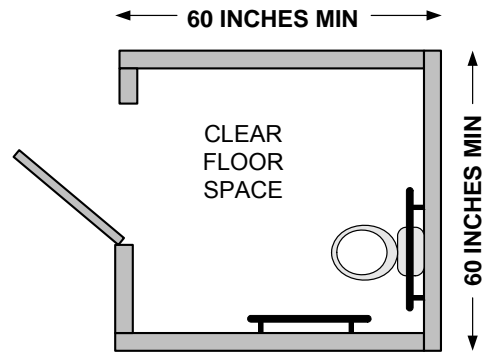

114. Where there is no stall with a clear floor space of five feet long and five feet wide, there is a stall that either 36 by 69 inches or 48 inches by 69 inches.

- Yes
- No
- N/A

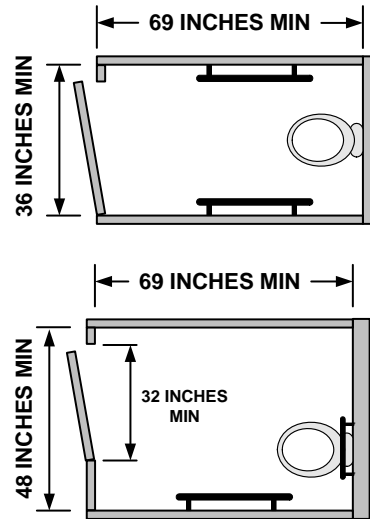

115. There is at least 18 inches of clear space at the latch side of the stall door (to get in and out).

- Yes
- No

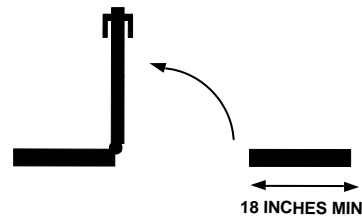

**NOTES : TOILET STALLS ONLY**

---



---



---



---



---



---



---



---

**(Proceed to next section!!)**

---

## **FOR TOILET ROOMS ONLY**

---

Mark "N/A" if toilet rooms do not exist (i.e., there are stalls only) **or** if room floor plan is not applicable.

---

116. Where the toilet is approached from the front and there is a sink alongside the toilet, there is clear floor space of at least 48 inches wide by 66 inches long (toilet wall to opposite wall).
- Yes  
 No  
 N/A

If door swings inward, measure space clear of door swing. This is easiest done with 2 people.

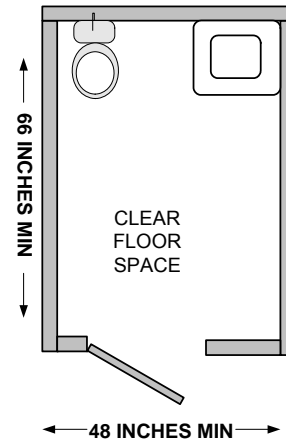

117. Where the toilet is approached from the side and there is a sink alongside the toilet, there is clear floor space of at least 48 inches wide by 56 inches long (toilet wall to opposite wall).
- Yes  
 No  
 N/A

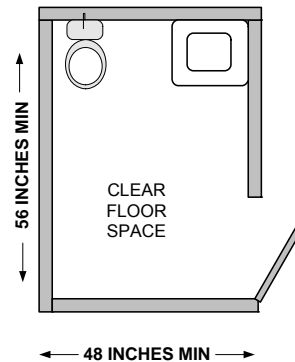

118. Where there is no sink alongside the toilet, there is a clear floor space of at least 60 inches wide by 56 inches long (toilet wall to opposite wall).
- Yes  
 No  
 N/A

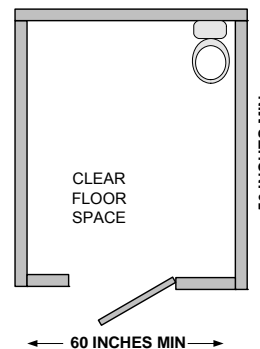

**NOTES : TOILET ROOMS ONLY**

---

---

---

---

---

---

---

---

---

***Emergency Egress (a route or path for going out in case of an emergency)***

---

119. The emergency route is at least 36 unobstructed inches wide.  Yes  No

If temporary objects protrude into passageway, then measure passageway to edge of object.

---

120. The emergency route does not require the use of stairs.  Yes  No

---

121. Exit doors along the emergency route are accessible doors.  Yes  No

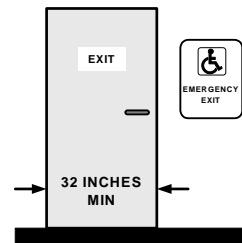

- 
122. Where emergency alarms are provided, they have flashing lights.
- Yes  
 No

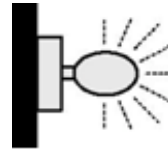

- 
123. Where emergency alarms are provided, they have audible signals.
- Yes  
 No

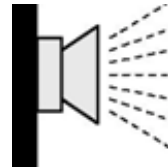

- 
124. Where emergency alarms are provided, additional visual alarms are installed in general use areas such as meeting rooms, hallways, lobbies and restrooms.
- Yes  
 No

---

NOTE: Visual/audible alarms should be installed as required by the National Fire Protection Association (NFPA) code 72 unless there are other state codes that take precedence.

- 
125. Each area of rescue assistance (where wheelchair users wait for evacuation) provides at least 2 clear spaces no smaller than 30 by 48 inches.
- Yes  
 No  
 N/A

NOTE: Areas of rescue assistance are not required in 1-story buildings without elevators. Mark "N/A" for ground-level facilities.

- 
126. Each stairway serving an area of rescue assistance is at least 48 inches wide between handrails.
- Yes  
 No  
 N/A
-

**NOTES : EMERGENCY EGRESS**

---

---

---

---

---

---

---

---

---

**Section 3: Exam Rooms and access to Primary Services**

---

127. There is a loaner wheelchair available.  Yes  No You may have to ask staff if a loaner wheelchair is not readily apparent.

---

128. There is a 36-inch clear passageway (excluding doorways) from the waiting area to designated exam room.  Yes  No

---

129. There is a method to weigh a wheelchair-user.  Yes  No

---

---

130. The clinic has at least one height-adjustable exam table (lowers to 17-19 inches).  Yes  No

---

131. There is at least one lift or transfer device available for use in exam room.  Yes  No  N/A

Mark "N/A" only if this feature is not needed. Consider whether a transfer device (e.g., step stool with arm support) is needed to get on exam table.

---

132. The designated exam room is large enough for a wheelchair user to enter, turn around, and exit.  Yes  No

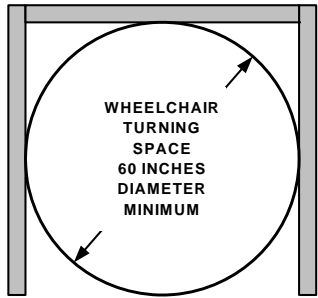

Note: This is a difficult measurement to make. It may require 2 people working together to make an accurate reading. Study the diagram closely, and take your time making your measurement.

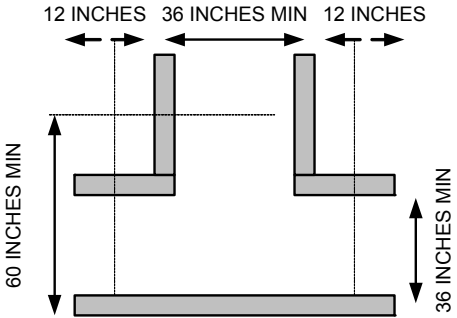

133. All controls (e.g., light switches, door handles) are operable with a closed fist.  Yes  No  N/A

Controls include light switches, locks, vending machines, television controls, fire alarms, etc.

Mark "N/A" if patient does not need to access controls in exam room.

---





---

**TOILET ROOMS WHERE LAB SPECIMENS ARE COLLECTED should meet the following standards.**

**If there is no toilet room with a specimen pass-through, mark each question in this part “N/A.”**

---

136. There is a toilet room where lab specimens are collected.
- Yes  
 N/A

Mark “NA” if there is not a toilet room reserved specifically for collecting lab specimens. If “NA” is marked, mark “NA” for the remaining questions in this section.

137. Signs are mounted 60 inches to the centerline on the wall on the latch side of the door, out of the way of the door swing.
- Yes  
 No  
 N/A

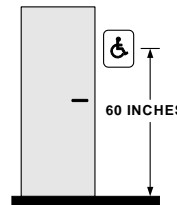

138. Where pictograms or symbols are used to identify rest rooms, Braille characters are included below them.
- Yes  
 No  
 N/A

Mark “N/A” if no pictograms are used.

139. Where pictograms or symbols are used to identify rest rooms, raised characters are included below them.
- Yes  
 No  
 N/A

Mark “N/A” if no pictograms are used.

140. The restroom doorway is at least 32 inches wide.
- Yes  
 No  
 N/A

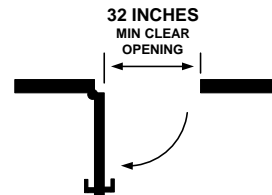

141. Door handles are operable with a single, closed fist.
- Yes  
 No  
 N/A

If door control is used, consider whether it is usable with a single, closed fist.

142. Door handles are placed no higher than 48 inches.
- Yes  
 No  
 N/A

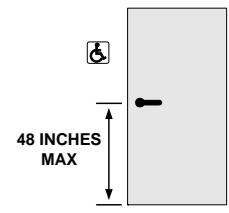

Mark "N/A" only if door is automatic and operable control is no higher than 48 inches.

143. The entry is large enough for a wheelchair user to enter, turn around, and exit.
- Yes  
 No  
 N/A

Note: This is a difficult measurement to make. It may require 2 people working together to make an accurate reading. Study the diagram closely, and take your time making your measurement.

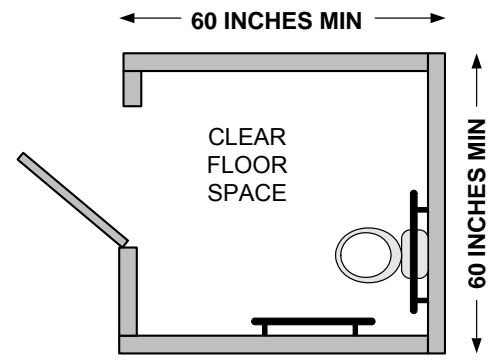

144. There is a 36-inch wide unobstructed path to all fixtures (e.g. sink, towel dispenser).
- Yes  
 No  
 N/A

145. The sink has a 30 inch wide by 48 inch deep clear space in front. A maximum of 19 inches of the required depth may be under the sink.
- Yes  
 No  
 N/A

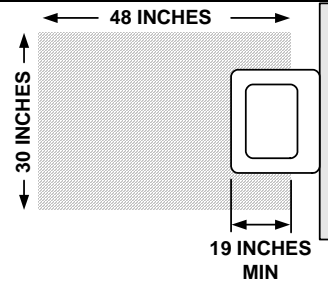

Mark "N/A" if there is no sink.

146. Pipes under the sink are insulated to protect against contact.
- Yes  
 No  
 N/A

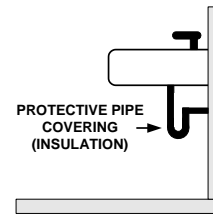

Mark "N/A" if there is no sink.

147. Where counters or tables are provided, the top is between 28 inches and 34 inches from the floor.
- Yes  
 No  
 N/A

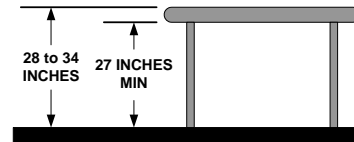

148. The sink rim is no higher than 34 inches.
- Yes  
 No  
 N/A

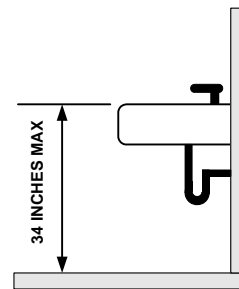

Mark "N/A" if there is no sink.

149. The faucet is operable with a single, closed fist.
- Yes  
 No  
 N/A

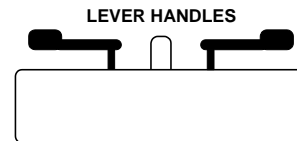

Mark "N/A" if there is no sink.

- 
150. The highest operable part of all dispensers and hand dryers is no higher than 48 inches.
- Yes  
 No  
 N/A

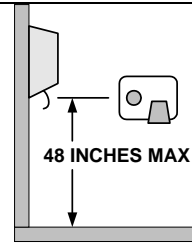

Mark "N/A" if there are no dispensers.

- 
151. All dispensers and hand dryers are operable with a single, closed fist.
- Yes  
 No  
 N/A
- (Pull-down paper-towel dispensers & many seat-cover dispensers are usually not accessible by this criteria.)

Mark "N/A" if there are no dispensers.

- 
152. The mirror is mounted with the bottom edge of the reflecting surface no higher than 40 inches.
- Yes  
 No  
 N/A

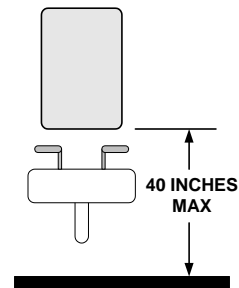

Note: This is a difficult measure to take and sometimes requires more than one measurement. Please use caution.

Mark "N/A" if there is no mirror.

---

153. There are horizontal grab bars on the wall behind the toilet and on side wall nearest to the toilet in the designated stall/toilet room.
- Yes  
 No  
 N/A

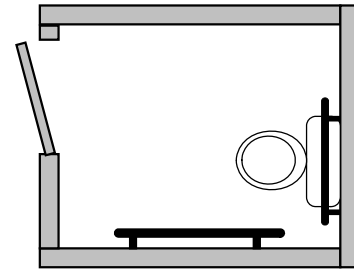

Mark "No" if grab bars are not present or are not positioned parallel to floor.

154. The toilet seat is 17 inches to 19 inches high.
- Yes  
 No  
 N/A

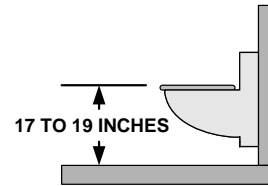

155. There are at least 18 inches of clear space from the center of the toilet to the wall(s) on either side.
- Yes  
 No  
 N/A

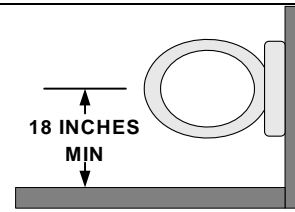

Note: Make measurement to adjacent wall. Do not include objects such as toilet paper dispensers in your measurement.

156. The window or ledge where urine samples are placed is no higher than 48 inches and is operable with a closed fist.
- Yes  
 No  
 N/A

Mark "N/A" if no window or ledge is available.

**(Proceed to next section!!)**

**FOR TOILET ROOMS WHERE LAB SPECIMENS ARE COLLECTED ONLY  
(Mark "N/A" if lab specimen collection toilet rooms do not exist or if room floor plan is not applicable.)**

157. Where the toilet is approached from the front and there is a sink alongside the toilet, there is clear floor space of at least 48 inches wide by 66 inches long (toilet wall to opposite wall).
- Yes  
 No  
 N/A

Note: If door swings inward, measure space clear of door swing. This is easiest done with 2 people.

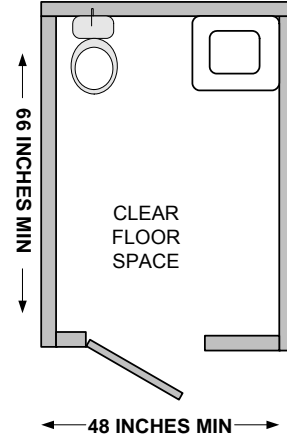

158. Where the toilet is approached from the side and there is a sink alongside the toilet, there is clear floor space of at least 48 inches wide by 56 inches long (toilet wall to opposite wall).
- Yes  
 No  
 N/A

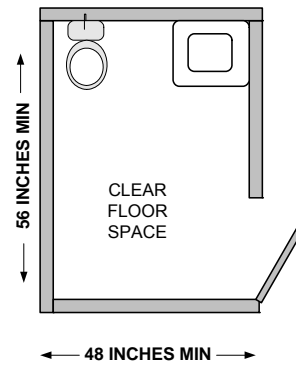

159. Where there is no sink alongside the toilet, there is a clear floor space of at least 60 inches wide by 56 inches long (toilet wall to opposite wall).
- Yes  
 No  
 N/A

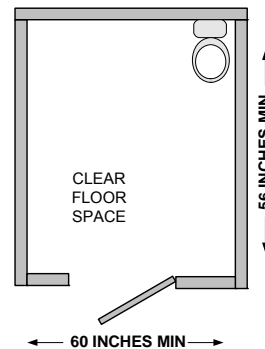



## Appendix A: Parking Requirements

Total Parking Spaces:	Required Minimum Number of Spaces:
1 to 25	1
26 to 50	2
51 to 75	3
76 to 100	4
101 to 150	5
151 to 200	6
201 to 300	7
301 to 400	8
401 to 500	9
501 to 1000	2% of total
1001 and over	20 plus 1 for each 100 over 1000

*Number of required parking spaces for outpatient units and facilities: **10 percent of the total number** of parking spaces provided serving each such outpatient unit or facility. **Note: When calculating the number of accessible spaces needed, round the number up to the next whole number if the number comes out unevenly. For example, if a lot has 83 spaces, 10 percent would be 8.3 spaces. It is required that the partial number be rounded up, so the number of spaces needed is 9.***



## Appendix B: Overall Scoring Sheet

# Your Overall Score

---

To calculate an overall score, please enter “1” for each item that received a YES or N/A mark next to the corresponding question number below.

<b>Section 1: Patient Arrival</b>	
Parking	
1	
2	
3	
4	
5	
6	
7	
Approach to Building	
8	
9	
10	
11	
12	
13	
14	
15	
16	
17	
Ramps	
18	
19	
20	
21	
22	
23	

Signage	
24	
25	
26	
27	
28	
29	
30	
31	
32	
33	
34	
35	
36	
Controls	
37	
38	
Doors	
39	
40	
41	
42	
43	
44	
45	

<b>Section 2: Public Facilities</b>	
Telephones	
46	
47	
48	
49	
50	
51	
52	
Seating	
53	
54	
Counters	
55	
56	
Passageways	
57	
58	
59	
60	
61	
62	
63	
Water Fountains	
64	
65	
66	
Lifts	
67	
68	
69	

Lifts (continued)	
70	
71	
72	
Elevators	
73	
74	
75	
76	
77	
78	
79	
80	
81	
82	
83	
84	
85	
Stairs	
86	
87	
88	
89	
90	
Restrooms	
91	
92	
93	
94	
95	
96	
97	
98	
99	
100	

Restrooms (continued)	
101	
102	
103	
104	
105	
106	
107	
108	
109	
110	
111	
112	
113	
114	
115	
116	
117	
118	
Emergency Egress	
119	
120	
121	
122	
123	
124	
125	
126	
<b><i>Section 3: Exam Rooms and Access to Primary Services</i></b>	
127	
128	

Exam Rooms (continued)	
129	
130	
131	
132	
133	
134	
135	
Lab specimen collection rooms	
136	
137	
138	
139	
140	
141	
142	
143	
144	
145	
146	
147	
148	
149	
150	
151	
152	
153	
154	
155	
156	
157	
158	
159	

## How to calculate your overall score

Example:

Count how many items you marked YES or N/A. If you answered YES or N/A to 145 items, your calculation would look like this:

$$\boxed{145} \text{ divided by } \boxed{159} \text{ multiplied by } 100 \text{ equals } \boxed{91\%}$$

(items marked YES or N/A)                      (total survey items)                      (percent usable)

Your clinic would be 91 percent usable for people with disabilities.

Now enter the total number of yes responses, divide by 159, and multiply by 100 for your score.

$$\boxed{\phantom{000}} \div \boxed{159} \times 100 = \boxed{\phantom{000}}$$

## Appendix C: Mobility Scoring Sheet

# Your Mobility Score

---

*To calculate a score for the mobility category, please enter “1” for each item that received a YES or N/A mark next to the corresponding question number below. There are 122 items that count towards the mobility score.*

Parking	
1	
2	
3	
4	
5	
6	
7	
Approach to Building	
8	
9	
10	
11	
12	
13	
14	
15	
16	
17	
Ramps	
18	
19	
20	
21	
22	
23	

Controls	
37	
38	
Doors	
39	
40	
41	
42	
43	
44	
45	
Telephone	
46	
47	
48	
Seating	
53	
54	
Counters	
55	
56	
Passageways	
57	
58	
59	
60	

# Your Mobility Score Continued

---

Passageways (continued)	
60	
61	
62	
63	
Water Fountains	
64	
65	
Lifts	
67	
68	
69	
70	
71	
72	
Elevators	
73	
77	
78	
79	
80	
84	
85	
Stairs	
90	
Rest Rooms	
94	
95	
96	
97	
98	

Rest Rooms (continued)	
99	
100	
101	
102	
103	
104	
105	
106	
107	
109	
109	
110	
111	
112	
113	
114	
115	
116	
117	
118	
Emergency Egress	
119	
120	
121	
122	
125	
126	
Exam Room	
127	
128	



# Your Mobility Score Continued

---

Exam Room (continued)	
129	
130	
131	
132	
133	
134	
Lab specimen collection rooms	
141	
142	
143	
144	
145	
146	

Lab specimen collection rooms (cont.)	
147	
148	
149	
150	
151	
152	
153	
154	
155	
156	
157	
158	
159	
Total items	121

## How to calculate your mobility score

Example:

Count how many items you marked YES or N/A. If you answered YES or N/A to 108 items, your calculation would look like this:

110

divided by

121

multiplied by 100 equals

91%

(items marked  
YES or N/A)

(total survey items)

(percent usable)

Your clinic would be 90 percent usable for people with mobility impairments.

Now enter the total number of yes responses, divide by 121, and multiply by 100 for your score.

÷

121

× 100 =

## **Appendix D: Sensory Scoring Sheet**

# Your Sensory Score

---

*To calculate a score for the sensory category, please enter "1" for each item that received a YES or N/A mark next to the corresponding question number below. There are 42 items that count towards the sensory score.*

Signage	
24	
25	
26	
27	
28	
29	
30	
31	
32	
33	
34	
35	
36	
Telephone	
49	
50	
51	
52	
Passageways	
62	
Water Fountains	
66	
Elevators	
73	
74	
75	

Elevators (continued)	
77	
79	
80	
82	
83	
84	
Stairs	
86	
87	
88	
89	
Rest Rooms	
91	
92	
93	
Emergency Egress	
122	
123	
124	
Lab specimen rooms	
137	
138	
139	
Total items:	41

## How to calculate your sensory score

Example:

Count how many items you marked YES or N/A. If you answered YES or N/A to 37 items, your calculation would look like this:

$$\begin{array}{ccc} \boxed{37} & \text{divided by} & \boxed{41} & \text{multiplied by 100 equals} & \boxed{90\%} \\ \text{(items marked YES or N/A)} & & \text{(total survey items)} & & \text{(percent usable)} \end{array}$$

Your clinic would be 90 percent usable for people with sensory impairments.

Now enter the total number of yes responses, divide by 41, and multiply by 100 for your score.

$$\boxed{\phantom{00}} \div \boxed{41} \times 100 = \boxed{\phantom{00}}$$

## Appendix E: Cognitive Scoring Sheet

# Your Cognitive Score

---

*To calculate a score for the cognitive category, please enter “1” for each item that received a YES or N/A mark next to the corresponding question number below. There are 8 items that count towards the cognitive score.*

24	
25	
26	
79	
122	
123	
124	
135	
Total items	8

## How to calculate your cognitive score

Example:

Count how many items you marked YES or N/A. If you answered YES or N/A to 7 items, your calculation would look like this:

$$\boxed{7} \text{ divided by } \boxed{8} \text{ multiplied by } 100 \text{ equals } \boxed{88\%}$$

(items marked YES or N/A)                      (total survey items)                      (percent usable)

Your clinic would be 88 percent usable for people with cognitive impairments.

Now enter the total number of yes responses, divide by 8, and multiply by 100 for your score.

$$\boxed{\phantom{00}} \div \boxed{8} \times 100 = \boxed{\phantom{00}}$$



*This publication is  
available in  
alternate formats  
upon request.*

---

We're on the web!  
[www.healthwellness.org](http://www.healthwellness.org)

---